

Varenummer: 2030100M1260A1S
 Beskrivelse: E+G Justerfod
 GN 30-100-M12-60-A1-S
 Note: S Uden møtrik, udvendig sekskant i bunden

Mål

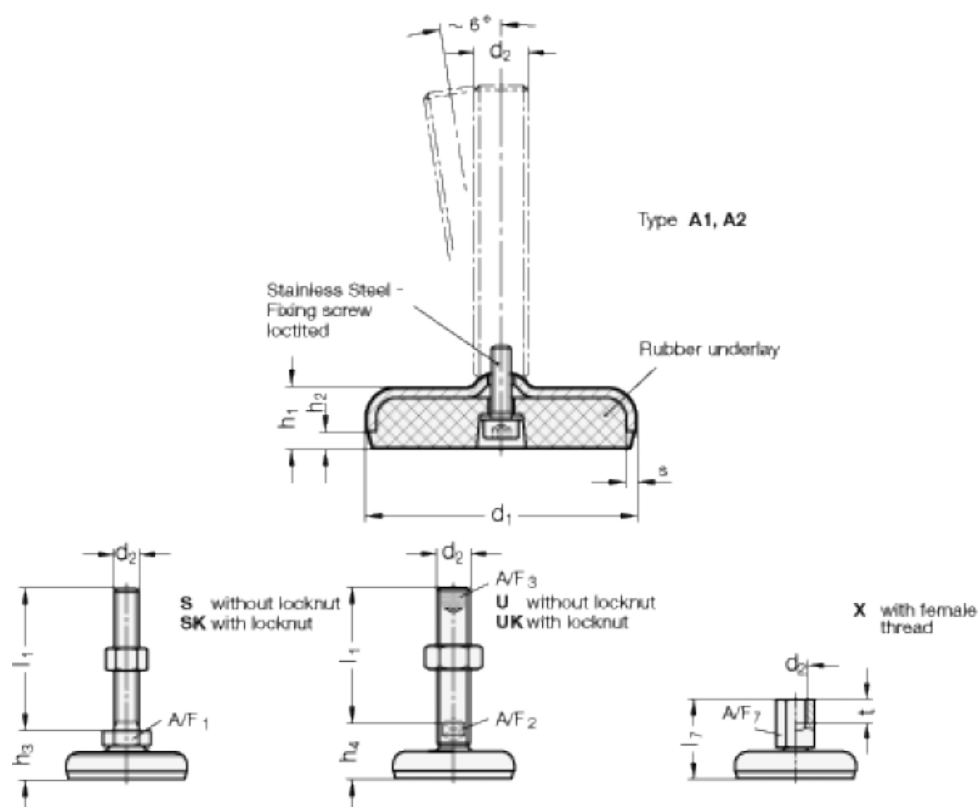

A/F1 = 17
 d_1 = 100
 d_2 = M12
 h_1 = 20
 h_2 = 6
 h_3 = 28
 l_1 = 60
 s = 3